



Hot Water Circulation

Hot Water Circulation

- Boiler Application
- General heating application





HOT WATER CIRCULATION



Glanded DRY Runner Pump PH Series

Feature:
 Light and excellent in design
 In-line
 Liquid Temp: up to 80 °C

Application:
 Hot water circulation and heating system

Specification

| Model | Power Source | | Power (kW) | | Head (m) | | | Rated Flow rate | | Max. Flow rate | | Weight (kg) | |
|----------|--------------|---------------|------------|------------|------------|--------------|----------------|-----------------|-------|----------------|--------------------|-------------|-------|
| | Voltage(V) | Frequency(Hz) | Input(p1) | Output(p2) | Total Head | Suction Head | Discharge Head | l/min | At Ht | l/min | m ³ /hr | Net | Gross |
| PH-022E | 220 | 50 | 0.05 | 0.02 | 2 | 0 | 2 | 25 | 1.0 | 37 | 2.2 | 4.5 | 5.0 |
| PH-045E | 220 | 50 | 0.09 | 0.04 | 4 | 0 | 4 | 28 | 2.5 | 48 | 2.9 | 4.5 | 5.0 |
| PH-046E | 220 | 50 | 0.09 | 0.04 | 4 | 0 | 4 | 28 | 2.5 | 48 | 2.9 | 4.5 | 5.0 |
| PH-101E | 220 | 50 | 0.02 | 0.10 | 5 | 0 | 5 | 85 | 3.0 | 140 | 8.4 | 9.5 | 10.0 |
| PH-123E | 220 | 50 | 0.26 | 0.12 | 5 | 0 | 5 | 150 | 3.0 | 170 | 10.2 | 13.0 | 13.5 |
| PH-251E | 220 | 50 | 0.52 | 0.25 | 8 | 0 | 8 | 210 | 4.0 | 300 | 18.0 | 20.5 | 21.0 |
| PH-252E | 220 | 50 | 0.52 | 0.25 | 8 | 0 | 8 | 210 | 4.0 | 300 | 18.0 | 20.5 | 21.0 |
| PH-253E | 220 | 50 | 0.52 | 0.25 | 8 | 0 | 8 | 210 | 4.0 | 300 | 18.0 | 20.5 | 21.0 |
| PH-254E | 220 | 50 | 0.33 | 0.25 | 15 | 0 | 15 | 50 | 10.0 | 110 | 6.6 | 13.0 | 13.0 |
| PH-400E | 220 | 50 | 0.80 | 0.40 | 16 | 0 | 16 | 180 | 10.0 | 317 | 19.0 | 26.0 | 27.0 |
| PH-401E | 220 | 50 | 0.90 | 0.40 | 19 | 0 | 19 | 110 | 16.0 | 272 | 16.3 | 26.0 | 27.0 |
| PH-401Q | 3 ∅380 | 50 | 0.90 | 0.40 | 19 | 0 | 19 | 110 | 16.0 | 250 | 15.0 | 26.0 | 27.0 |
| PH-1500Q | 3 ∅380 | 50 | 1.80 | 1.50 | 25 | 0 | 25 | 200 | 20.0 | 417 | 25.0 | 38.0 | 40.0 |
| PH-2200Q | 3 ∅380 | 50 | 2.90 | 2.20 | 30 | 0 | 30 | 250 | 25.0 | 500 | 30.0 | 38.0 | 40.0 |



PH-022E



PH-101E



PH-1500Q

Outline Drawing

PH-022E

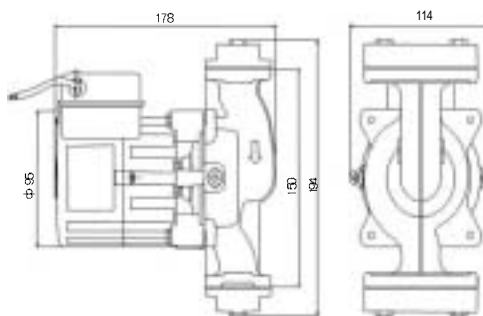

PH-045E

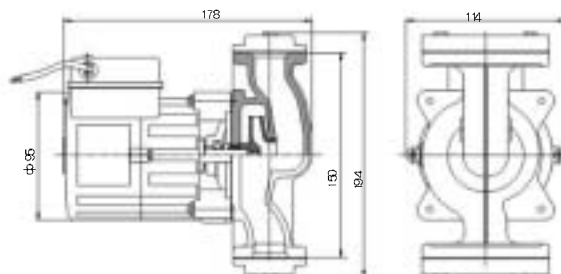

HOT WATER CIRCULATION



Performance Curve

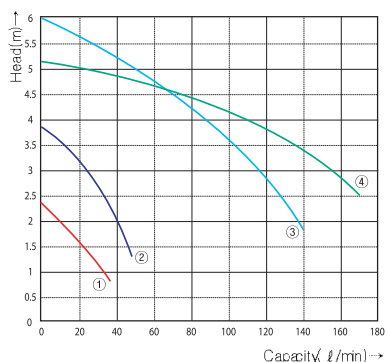

- ① PH-022E ② PH-045E, 046E
- ③ PH-101E ④ PH-123E

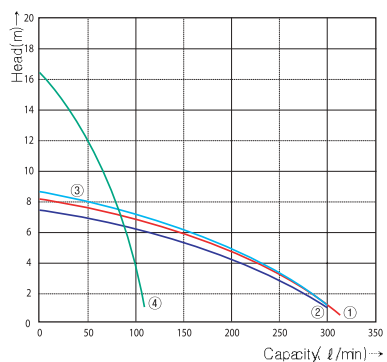

- ① PH-251E ② PH-252E
- ③ PH-253E ④ PH-254E

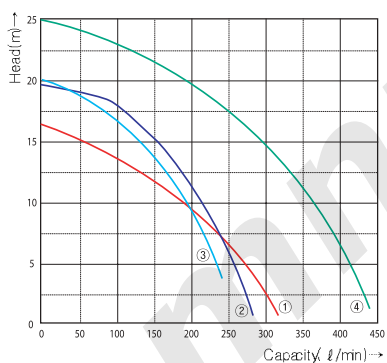

- ① PH-400E ② PH-401E
- ③ PH-401Q ④ PH-1500Q

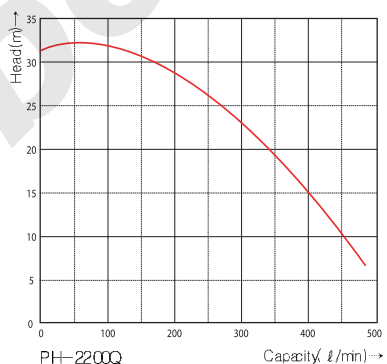

PH-2200Q

Outline Drawing

PH-046E

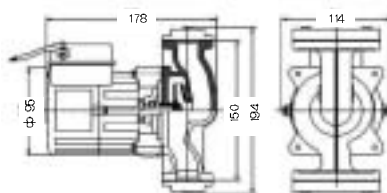

PH-101E

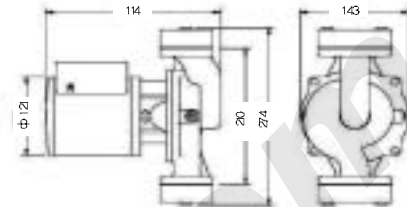

PH-101E

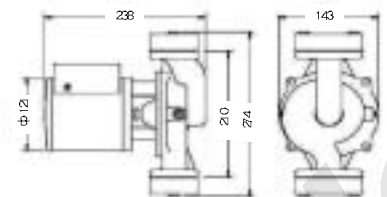

PH-123E

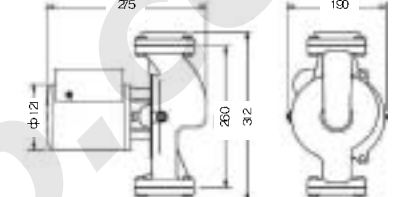

PH-251E

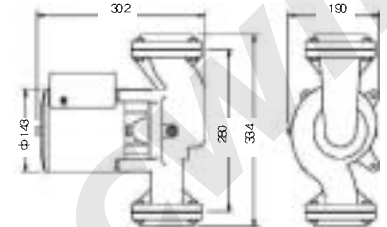

PH-252E

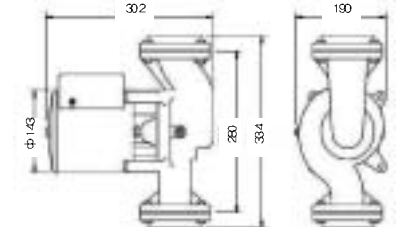

PH-253E

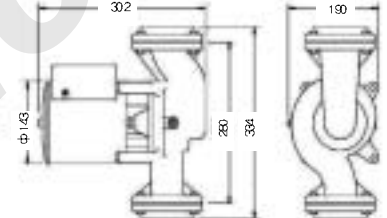

PH-254E

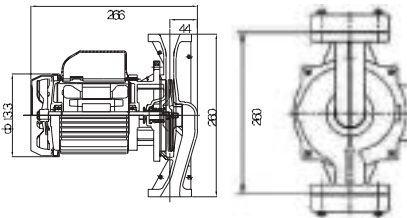

PH-400E

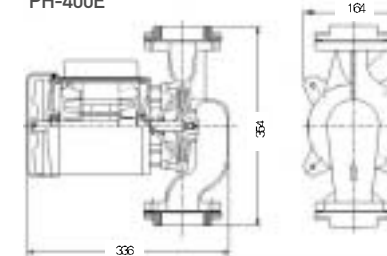

PH-401E/Q

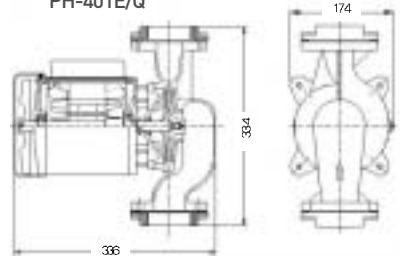

PH-1500Q

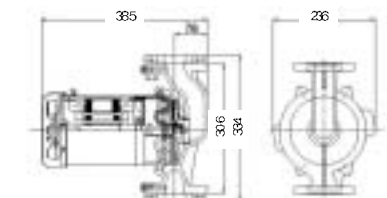

PH-2200Q

